



PX501

Quick Start Guide



Accessory

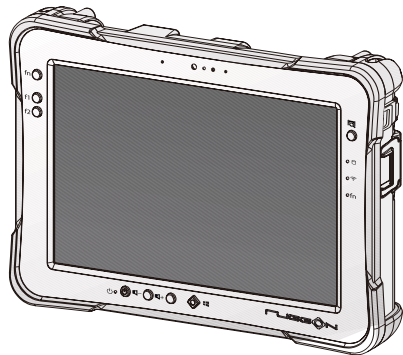

PX501

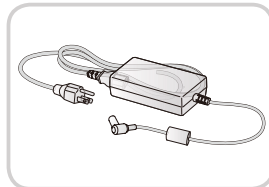

Power adapter

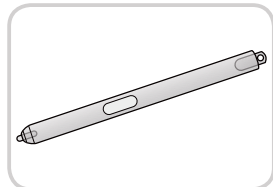

Stylus or Digitizer

Overview

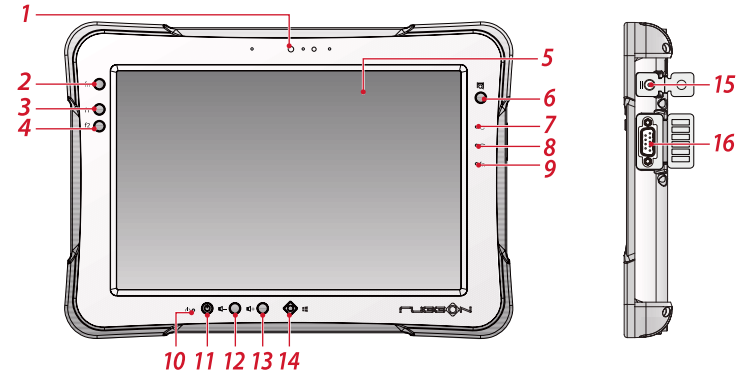

- | | | |
|-------------------|---------------|---------------|
| 1 Front camera | 7 Battery LED | 13 Volume + |
| 2 FN key | 8 Wi-Fi LED | 14 Home key |
| 3 F1 key | 9 FN LED | 15 DC-IN jack |
| 4 F2 key | 10 Power LED | 16 RS-232 |
| 5 Touch screen | 11 Power key | |
| 6 Barcode trigger | 12 Volume - | |

Note: To prevent damage or malfunction, always dry the touch screen when wet.

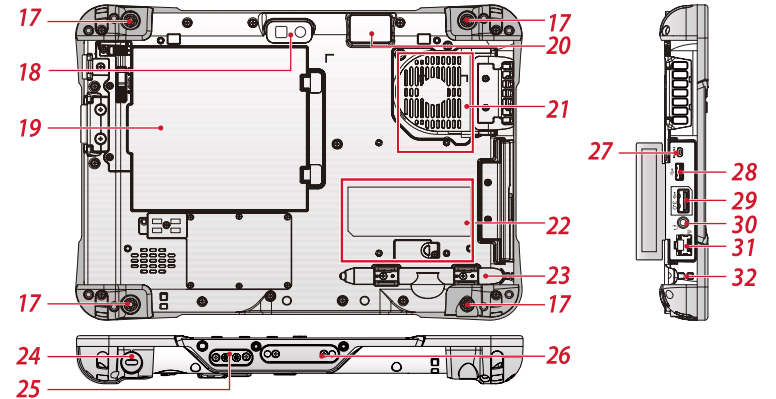

- | | | |
|-------------------|----------------------|-------------------|
| 17 Securing holes | 23 Digitizer holder | 29 USB 3.1 Type A |
| 18 Rear camera | 24 Kensington lock | 30 Audio jack |
| 19 Battery | 25 Pass-through | 31 Ethernet |
| 20 Barcode reader | 26 Docking connector | 32 Tether hole |
| 21 Fan | 27 Micro HDMI | |
| 22 Expansion bay | 28 USB 3.1 Type C | |

Charging & Power On



First Time Use

PX501 is under “Battery Ship Mode” and will not power on to preserve the battery and prevent power loss. To enable “Regular Mode” and activate the battery, please connect the power adapter to power on.

1. Install the external battery cover over the battery connector.
2. Flip open the DC-IN cover to expose the DC-IN jack.
3. Connect the AC adapter to the DC-IN port.
4. After charging, disconnect the AC adapter.
5. Replace the DC-IN cover by angling the rear side at an angle.
6. Press the front open end down in the compartment to seal in place.
7. After PX501 is fully charged press and hold the power button until the screen lights. The device runs through the start up sequence and powers up.

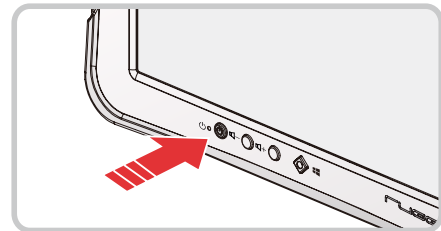
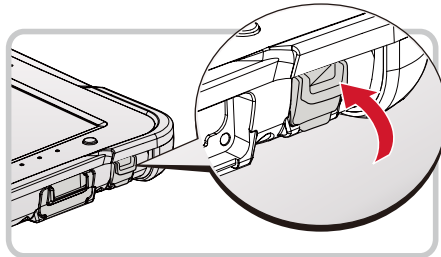
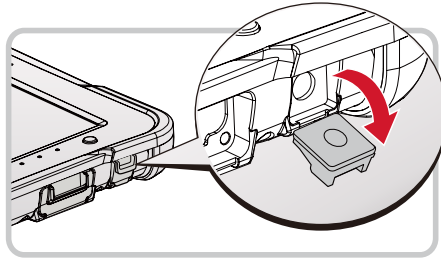

Installing the Micro SIM Card (Optional)

The device includes a micro SIM card slot for cellular and wireless connection. Only a micro SIM card is supported in the slot.

1. Power off the PX501.
2. Remove the service door and its screws.
3. Disconnect the antenna and remove the 4G LTE card (optional) from the slot.

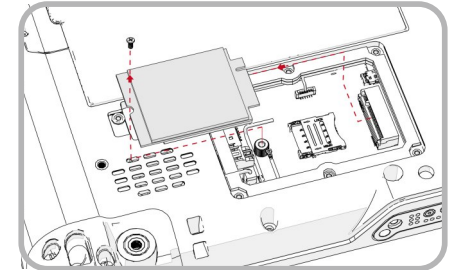
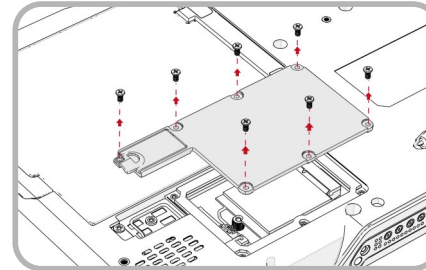

4. Take the micro SIM card from its packaging.
5. Push the SIM card cover to open and place the micro SIM card to the slot.
6. Close the SIM card cover.

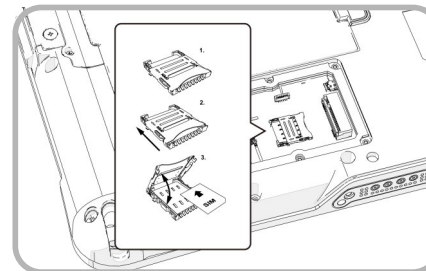

7. Install the 4G LTE card and its antennas to the slot and close the service door.